



Next Generation Tableting Technology

# FE55



**CONTAINMENT  
GUARD**

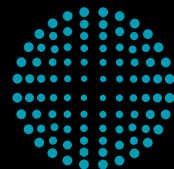

**FETTE  
COMPACTING**  
be efficient

# How do you produce efficiently...

**... when you want to cover very different requirements with one machine type?**

**The FE55 is the only machine in its performance class with which users can manufacture, as standard, more than 90% of all products without additional investment or complex refitting. With up to 87 punches in 1.6 square meters, it offers a unique ratio of punch count to footprint. Therefore, it sets standards for the three central factors of efficiency in tableting – productivity, flexibility and availability. And the Fette Compacting TRI.EASY design ensures ease of use when operating, refitting or servicing.**

**Discover the next generation of tableting technology.**



**reddot** design award  
winner 2012

# Fette Compacting FE55 – The standard for efficiency in tableting



**FETTE**  
COMPACTING

Three factors are decisive for efficiency in tablet production: productivity, flexibility and availability. The FE55 sets standards in each of these areas:

- + Innovative filling system for easy and safe feeding of even complex product blends
- + Up to 50 % higher production output thanks to unique ratio of punch stations to footprint (up to 87 punch stations on 1.6 m<sup>2</sup>)
- + The only machine of this size for the production of single- and bi-layer tablets as well as offering the possibility of direct compression
- + Unique, patented system for first layer sampling during production
- + Innovative internal tablet discharge for guaranteed smooth production





# FE55 – Innovations for your productivity



**FETTE**  
COMPACTING

## **Innovative compression stations**

- + Smooth-running compression rollers for ultra-simple handling
- + Three compression rollers for the ultimate flexibility
- + Single, direct compression and bi-layer compression
- + Direct compressing using a third compression roller
- + Bi-layer tableting with identical compression rollers and filling devices
- + 83 % longer compression dwell time in combination with FS19® punches
- + Patented system allows sampling of the first layer in less than four seconds during production
- + Compression rollers can be moved quickly to a parking position for easy turret exchange
- + Extremely easy load cell exchange during product changeovers

## **Machine design**

- + Housing made of FDA-certified high-performance polymer
- + Optimal geometric surfaces for easy handling and fast cleaning
- + All product contact parts are made of stainless steel or FDA/GMP certified materials
- + 360 degree accessibility
- + Window flaps can be opened without disconnecting Process Equipment

- + Dust-proof and hermetically-sealed electrical cabinet – therefore no contact with ambient air

## **Unique tablet discharge**

- + Easy operation
- + Fast and safe tablet sorting and sampling for maximum product security
- + Significantly less floorspace thanks to innovative tablet discharge through the column
- + 360 degree accessibility
- + Compact unit without cables or hoses
- + Dust-proof design
- + All product contact parts are made of stainless steel, cleaning is fast and efficient

## **Modern Torque-drive**

- + High-performance, direct torque drive
- + Maintenance-free and energy-efficient
- + Alternatively external or integrated electrical cabinet for maximum flexibility
- + Power and control sections are separate
- + Electrical cabinet with innovative cooling concept
- + All Process Equipment and machine connections on a single panel

## **Innovative turret**

- + Unique ratio of punch count to footprint guarantees maximum flexibility
- + Compression rollers can be driven into parking position for easy turret change
- + Turret options for all applications
- + Easy turret exchange with cams and segments
- + Fast format changeover thanks to segments installed
- + Coded tablet scraper
- + Turret featuring coding ring for avoiding assembly errors
- + One central, multi-functional connector for oil, air and electricity
- + Flexible use also of segment or die turrets

# TRI.EASY Design – Ease of operation as the key to efficiency

The Fette Compacting TRI.EASY design permits uniquely easy and reliable operation. The idea behind it: efficiency is only possible when the technology is equally easy in the three dimensions of operating, refitting and servicing.

The TRI.EASY design is oriented precisely around the needs of the user, offering comprehensive help to make every task more straightforward. A short learning curve and significantly more secure handling on the part of the operating personnel, ensure maximum product quality even with the most demanding tasks.

## Features

- + Plug-and-Play design
- + Dismantling and assembly without tools
- + Machine controller detects the turret configuration
- + No external handling system required for turret exchange

## Benefits

- + Very easy handling since adjustments are no longer necessary
- + Fast, easy exchange and cleaning
- + Parameters are configured automatically



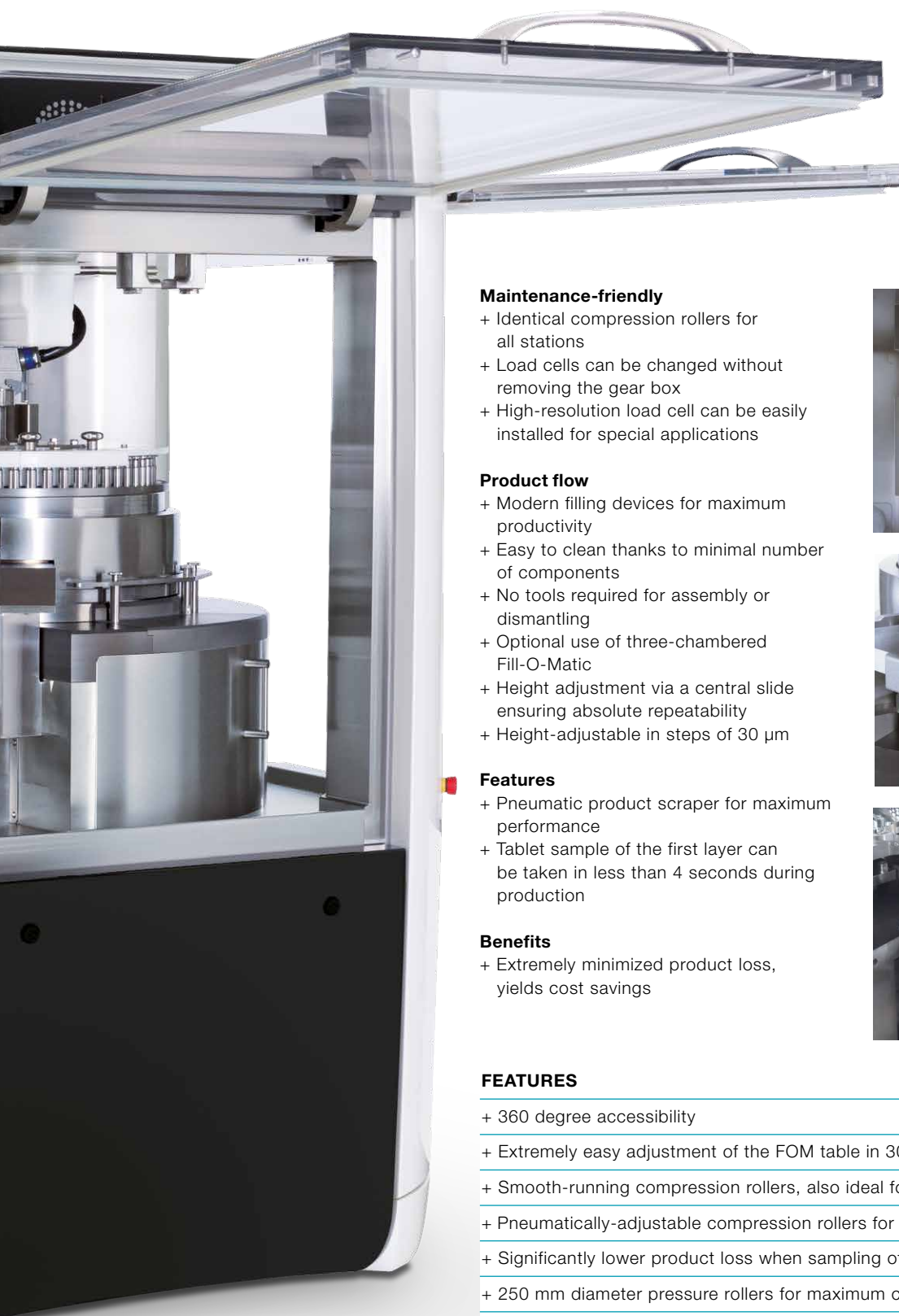

#### **Maintenance-friendly**

- + Identical compression rollers for all stations
- + Load cells can be changed without removing the gear box
- + High-resolution load cell can be easily installed for special applications

#### **Product flow**

- + Modern filling devices for maximum productivity
- + Easy to clean thanks to minimal number of components
- + No tools required for assembly or dismantling
- + Optional use of three-chambered Fill-O-Matic
- + Height adjustment via a central slide ensuring absolute repeatability
- + Height-adjustable in steps of 30 µm

#### **Features**

- + Pneumatic product scraper for maximum performance
- + Tablet sample of the first layer can be taken in less than 4 seconds during production

#### **Benefits**

- + Extremely minimized product loss, yields cost savings



#### **FEATURES**

- 
- + 360 degree accessibility
  - + Extremely easy adjustment of the FOM table in 30 µm steps
  - + Smooth-running compression rollers, also ideal for low compression forces
  - + Pneumatically-adjustable compression rollers for first-layer sampling
  - + Significantly lower product loss when sampling of first-layer
  - + 250 mm diameter pressure rollers for maximum compression dwell time
  - + Control components are separate from power components
  - + Fewer plug-in connections mean easier assembly
  - + Dust-proof and hermetically sealed electrical cabinet
  - + Coded turret allows controller to detect configuration
-

# Fette Compacting HMI – Easy and safe operation guaranteed







### HMI software to support the operation

New Visual 8 operating software from Fette Compacting

- + New 19" "Touch Only" machine operation
- + Country-specific keyboard layouts possible, unique tactile feedback
- + Touch sensitive keys for start, stop and special functions with feedback for easy operation
- + Ultra Vision screen display for maximum contrast even in difficult lighting conditions
- + Microsoft Windows embedded operating system, future-proof operating system
- + SQL Server database, Real-time intelligence
- + Dust-tight USB port, no mechanical drives
- + All surfaces easy to clean, no ventilation slots or openings, ergonomic operator height

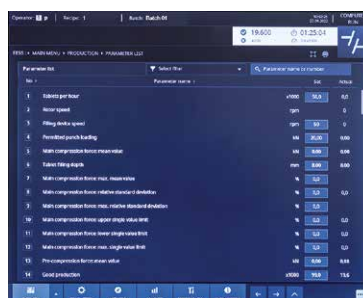
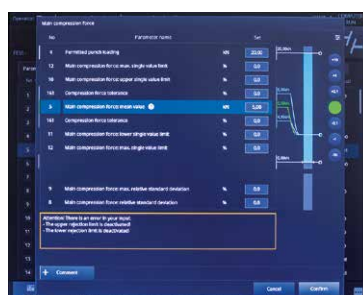

### Access to the main turret functions

- + Missing punches and punches that need to be rejected can easily be selected with a touch
- + Ready-grouped parameters for easy operation
- + Hot-keys for quick adjustment of the most important parameters
- + Drag and drop parameter lists for an individualized view
- + Search function within the parameter list
- + Different input dialogs for particular parameters
- + A comment line can be used for each individual parameter
- + Critical parameters can only be changed in conjunction with another operator (as a second set of eyes)

### FEATURES

- + Clear process graphics showing all necessary parameters
- + New Visual 8 operating software
- + Individually configurable parameter lists
- + New 19" "Touch Only" machine operation
- + Terminal made of FDA-certified high-performance polymer
- + HMI and software identical for the entire FE Series

### BENEFITS

- + Easy, intuitive operation through self-explanatory pictograms
- + Direct access to Fette Compacting presses
- + Fast, easy machine operation
- + Country specific keyboard layouts possible
- + Smooth, easily cleaned surfaces
- + Intuitive operation of the FE Series for the user



# Optional Containment Package



Maximum operative protection is the key feature of Fette Compacting's containment concept. The need for the highest possible operative safety during tableting can only be achieved through the right technological solutions and tablet manufacture that is largely automated. A tablet press has to compress powders and granulates securely and efficiently.

The tableting process is fully automated. The containment is never interrupted – from filling the machine right through to the removal of the tablets. In the event that the machine stops it must be possible for the operative to access the tablet press manually from all sides without breaking the containment.

Glove ports and rapid transfer ports in window flaps are the most important techniques for achieving this. The containment system from Fette Compacting has been developed for maximum operative safety and system security. All the glove ports and window flaps are linked into the safety control system, from where they are monitored. Incorrect operation is almost impossible.

## Product feed through a containment flap system

- + Receiving frame for decoupling vibrations from the product feed and the flap valve
- + HEPA H13 supply air filter
- + Pressure sensor for continuous, real-time monitoring of the positive pressure for maximum safety
- + Sensor-monitored, switchable vacuum system for preliminary manual cleaning by means of a hand vacuum hose and standard vacuum extraction for production operation

## Compression chamber optimally designed for cleaning

- + Reduced dust exposure through optimum compression chamber design
- + Maximum operative protection
- + No dust outside the machine
- + All parameters adjustable from the HMI
- + The compression chamber is dust-proof

## Glove ports

- + Safety sensor in every glove port for maximum operative safety
- + Ergonomic design
- + The whole of the interior of the compression chamber can be reached
- + Tools and/or filling cams can be introduced under containment conditions

## Rapid Transfer Port

- + The rapid transfer port (RTP) allows material to be introduced to and removed from a containment system
- + Tools, punches and filling cams can be introduced under containment conditions

## New window flaps

- + Double safety barrier system
- + Window flap sensors for opening, closing and pneumatically locking the window flaps
- + The individual window flaps are monitored, and their status displayed, at the HMI





**FEATURES**

**BENEFITS**

+ It is possible to avoid the release of dust during manufacture, preparation for cleaning or other interaction under containment conditions, and without interruption of the containment

+ Special safety clothing is not necessary during production, saving both cost and time

+ No contact with toxic products

+ Operatives are protected from dirt and contamination

+ Dust-proof compression chamber inside the machine

+ Safe environment during manufacture

+ Fail-safe operation and control of the machine

+ Maximum operative safety during the entire production process, reduce costs in operation

+ Fail-safe locking of all four window flaps

+ Ideal, reliable protection



- + Maximum safety through monitoring at the operative level
- + Only authorized operatives can access the containment controls
- + Access to the control system for locking and unlocking
- + Access to the controller for monitoring the glove ports
- + Logging all operative input and changes to the log
- + Sensor for low pressure monitoring
- + Individual locking and unlocking of the window flaps
- + Fail-safe locking of all four window flaps
- + Display of the switchable extraction equipment
- + Can be switched between extraction system in the machine and vacuum hose
- + Audible and visual safety instructions in the event of a leak
- + Individual monitoring system for every glove port

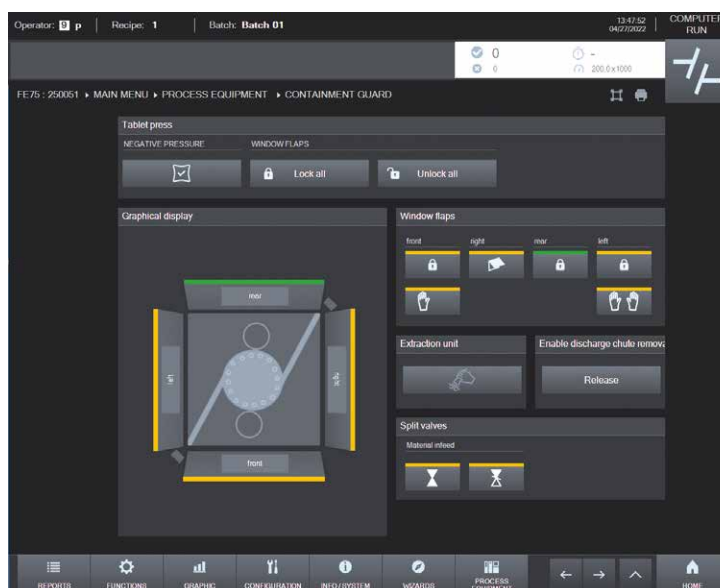
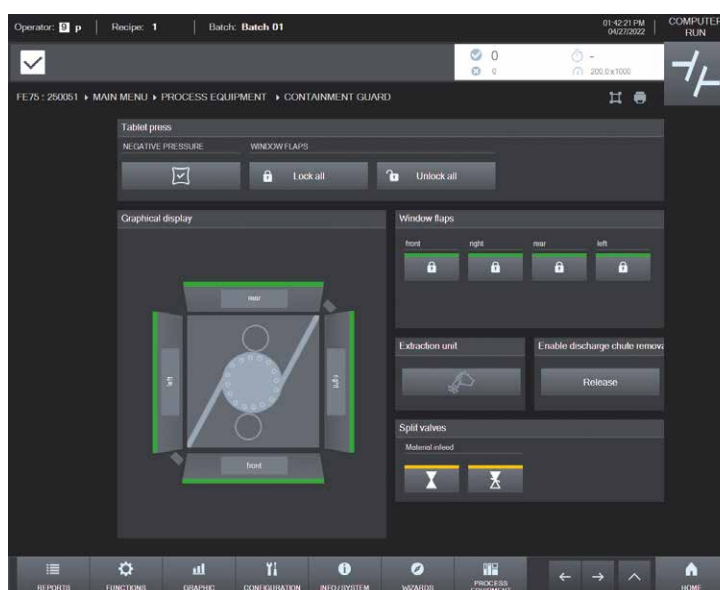

# Dimensions

## Standard floor plan

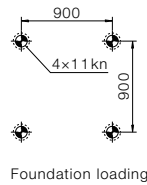
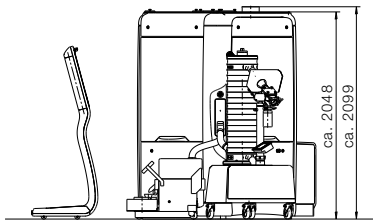
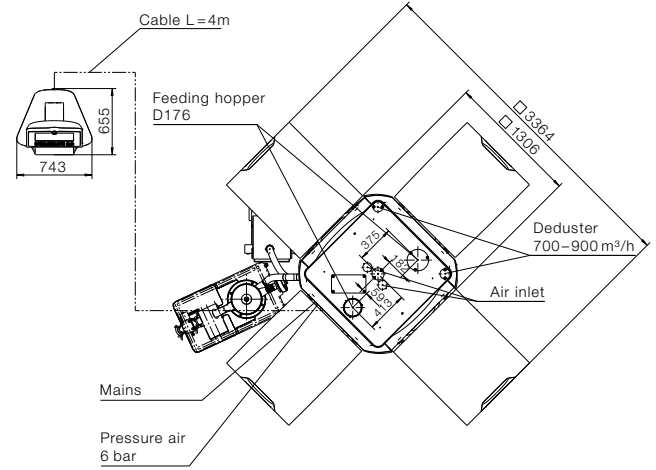
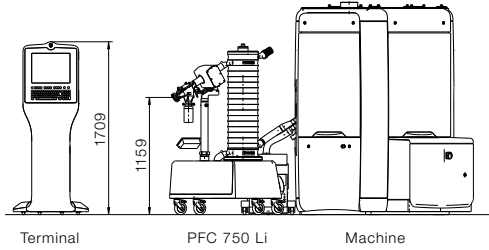

Pressure air min 6 bar for  
turret clamping system  
+ Dosing head  
+ Option: air reject system

Main 400 / 440 / 480 V – 50–60Hz  
Connection 4 × 10 mm²

## Containment floor plan

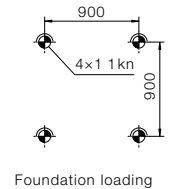
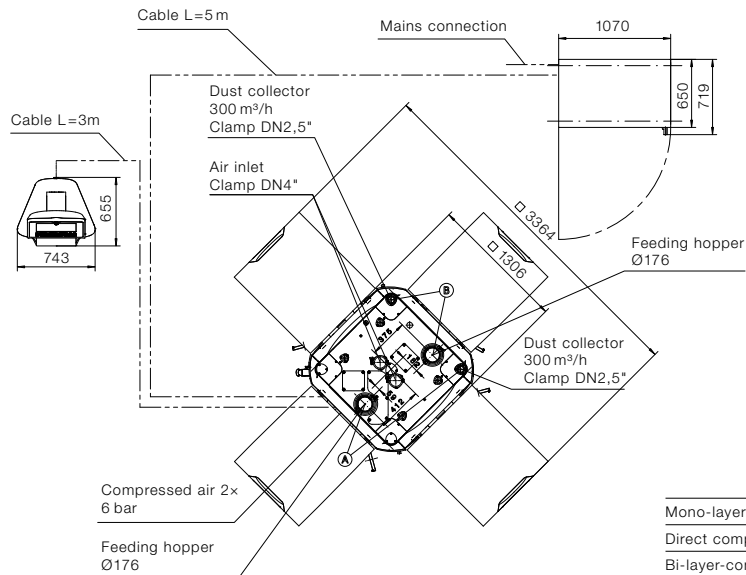
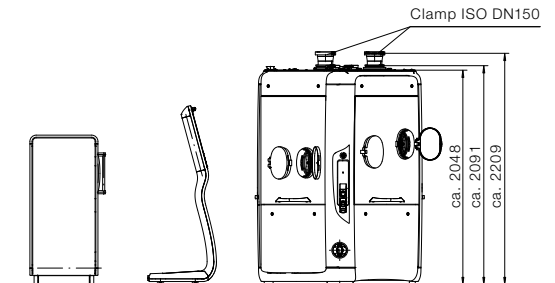
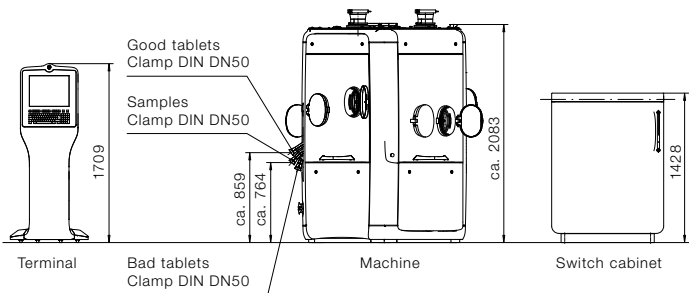

Dust extraction tablet press  
600 m³/h

Compressed air min.  
6 bar, 550 Ltr./min.

Operating voltage  
400–480 V, 3 Ph, 50/60 Hz

Power consumption  
16 kW

	A	B
Mono-layer-compression		X
Direct compression	X	
Bi-layer-compression	1. Layer	2. Layer

Segments (S) / Dies (M)		S	S	S	D	D	D
<b>Number of punch stations</b>		87	60	45	58	47	39
<b>Punch type</b>		FS12®	FS19®/ EU19 FS®/ EU19 TSM19	EU1"/ EU1"-441 TSM1"	FS19®/ EU19 FS®/ EU19 TSM19 BB	FS19®/ EU19 FS®/ EU19 TSM19 B	EU1" EU1"-441 TSM1"  D
<b>Tablet output units/h</b>	min.	78,300	54,000	40,500	52,200	42,300	35,100
	max.	626,400	432,000	243,000	417,600	338,400	210,600
<b>Max. compression force 1*</b>	kN	34	100	100	100	100	100
<b>Max. compression force 2*</b>	kN	34	100	100	100	100	100
<b>Max. compression force 3*</b>	kN	34	100	100	100	100	100
<b>Max. tablet diameter</b>	mm	11	18	25	18	18	25
<b>Max. filling depth 1st layer**</b>	mm	20	20	20	18	18	18
	2nd layer	mm	8	8	8	8	8
<b>Pitch circle diameter</b>	mm	550	550	550	550	550	550
<b>Turret rotation speed min.</b>	min. <sup>-1</sup>	15	15	15	15	15	15
	max.	min. <sup>-1</sup>	120	120	90	120	120
<b>Segment / Die height</b>	mm	25	25	25	22.225	22.225	23.8
<b>Die diameter</b>	mm				22	30.16	38.1
<b>Punch shaft diameter</b>	mm	12	19	25.35	19	19	25.35
<b>Punch length Upper/lower punch</b>	mm	133.6	133.6 (133.35)	133.6 (133.35)	133.6 (133.35)	133.6 (133.35)	133.6 (133.35)
<b>Upper punch insertion depth</b>	mm	1-4 (8***)	1-4 (8***)	1-4 (8***)	1-4 (8**)	1-4 (8**)	1-4 (8**)
<b>Dimensions</b>	mm	1,306 × 1,306 × 2,048 without integrated switch cabinet 1,306 × 1,626 × 2,048 with integrated switch cabinet					
<b>Weight</b>		Tablet press 3,700-3,900 kg, operating terminal 100 kg, switch cabinet 350 kg					
<b>Electrical supply parameters</b>		Operating voltage 400-480 V, 50/60Hz, power consumption 16 kW					

Theoretical values or technical limits: These can vary in practice, according to product and application.

Tablet thickness is a size dependent on product and can strongly vary.

\* limited by punch properties

\*\* special filling depth available on request

\*\*\* 2-layer-operation

# SmartInterface – Real-time data, at all times, and independent of location



## Machine monitoring in real time

The SmartInterface is a server based application enabling the monitoring of tablet press production parameters and HMI settings via mobile devices (Laptop, Tablet, Smartphone etc.). The user can obtain an overview of the current production and machine status **at any time and independent of location**, and download data and protocols, for example. This helps everyone involved in production to maintain full control of the manufacturing process. Operators can react faster to deviations as they are informed of the current status at all times. The application is available on all standard web browsers via the company's network. Accordingly, only the user's own IT security guidelines apply.

## KEY BENEFITS

- + Retrieve data at any time and from anywhere, even in editable formats such as Excel, without blocking the machine or impacting production
- + Process acceleration through easy and fast access to production parameters and HMI settings
- + Data update <1s (dependent on the customer network and capacity utilization)
- + Less ways to the machine and personal protective equipment required
- + Access subject to the customer's IT security guidelines
- + Access rights also based on HMI access rights
- + No validation-relevant change in case of a later upgrade



## Process graphic

The process graphic offers in-house monitoring of production parameters in real time.

## Monitoring all process data

The monitoring functions can be used to record and export all process values and utilize them for analyses.

## KPI dashboard

The KPI dashboard provides an overview of the current production and machine status.





## TECHNICAL REQUIREMENTS

- + Compatible machine types with HMI software level Visual 7 or higher (FE Series, new i Series, FE CPS)
- + FE Series: Using or upgrading to an APC910 unit enables full functionality and performance
- + FE Series: When using an APC810 unit test operation is possible
- + The machine must be integrated in an IT network (TCP/IP)
- + The mobile device must be within the machine network or communication (e.g. via network routes) must be possible
- + The appropriate firewall rules must be entered connection specific

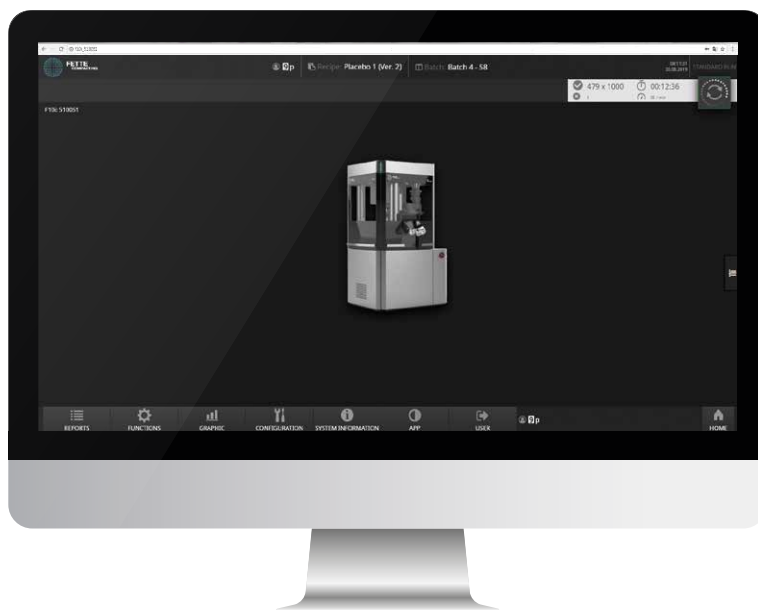

# Pmax<sup>®</sup> turret – more production capacity without higher investments

FS12<sup>®</sup> increase  
up to 40% more output

Yield  
(Tablets/h)

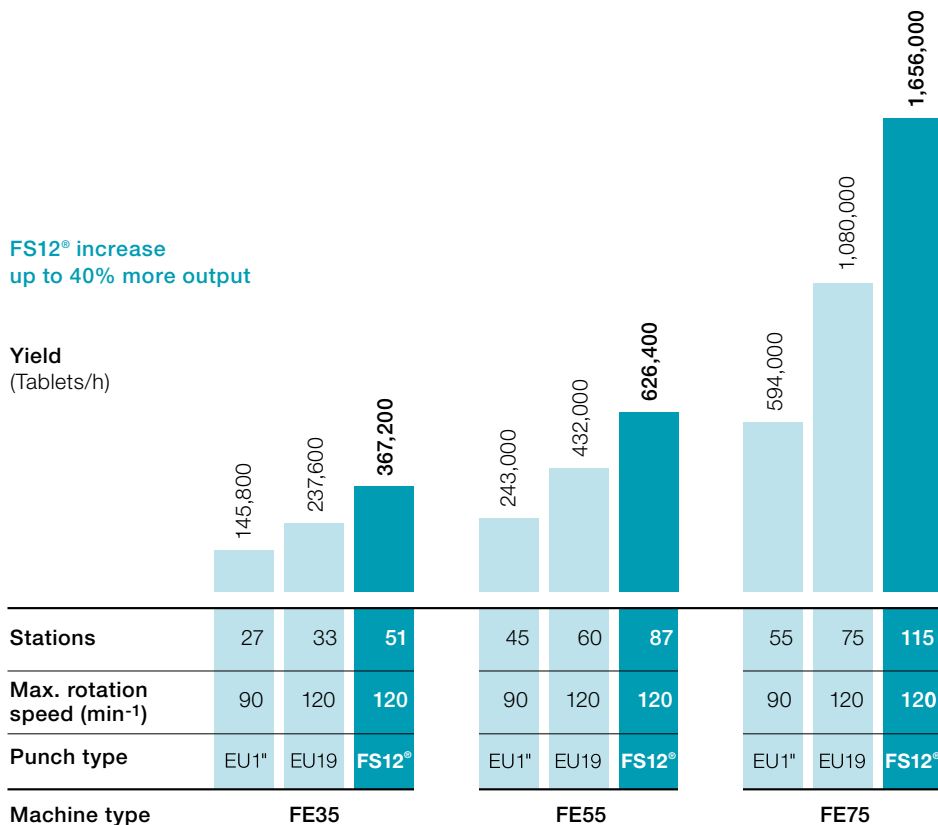

Stations	27	33	51	45	60	87	55	75	115
Max. rotation speed (min <sup>-1</sup> )	90	120	120	90	120	120	90	120	120
Punch type	EU1"	EU19	FS12 <sup>®</sup>	EU1"	EU19	FS12 <sup>®</sup>	EU1"	EU19	FS12 <sup>®</sup>
Machine type	FE35			FE55			FE75		

## FEATURES

- + Optimized punch head
- + Higher number of punches per compression
- + More punches at the same time under the compression station
- + No further machine investments necessary
- + Production parameters and characteristics stay unchanged
- + Single tablet rejection of bad tablets
- + Single compression force measurement even with small tablet diameters

## BENEFITS

- + Long dwell times
- + Up to 40 % higher output
- + Smooth machine running
- + Higher return on investment
- + No further machine adjustments necessary
- + 100 % quality assurance through in-process-control
- + Approved alternative to multi-tip tooling



Whether round tablets, special shapes, relief moldings, concavities or break lines – Fette Compacting can handle the full range of customer requirements. To ensure maximum output and flexibility, we offer punches in all sizes and types. For customers with special demands on their production, we particularly recommend the FS® products.

It is not just the diameter of the contact area that is critical; but furthermore the optimised transition geometries into the head radius which are featured by our FS® technology transmit the compression forces in an optimum way.

## Fette Compacting – Punch head types

### FS Technology®

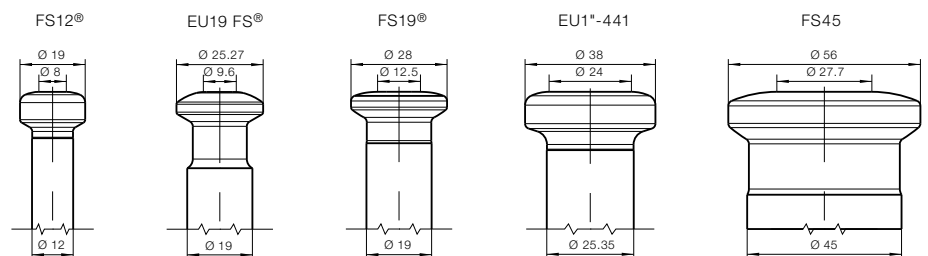

### Standard

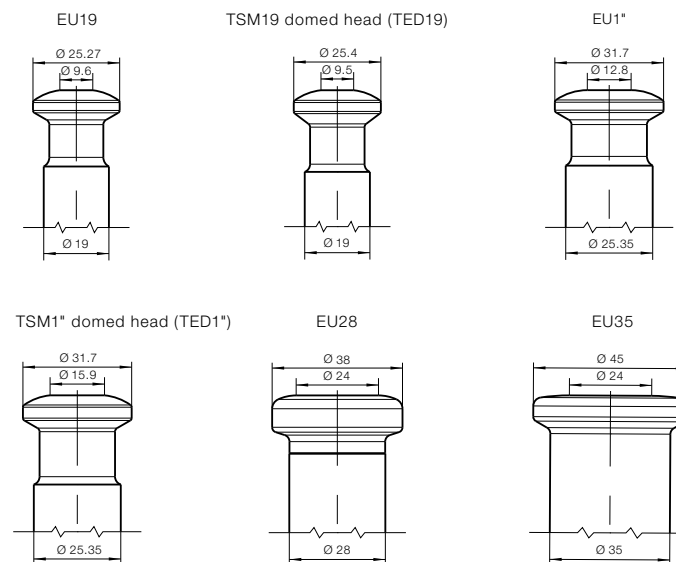

All measurements are in mm

© by Fette Compacting GmbH  
This publication may not be reprinted in whole or part without our express permission. All rights reserved. No rights may be derived from any errors in content or from typographical or typesetting errors. Diagrams, features and dimensions represent the current status on the date of issue of this leaflet. We reserve the right to make technical changes. The visual appearance of the products may not necessarily correspond to the actual appearance in all cases or in every detail.

**Fette Compacting GmbH**

Grabauer Strasse 24  
21493 Schwarzenbek, Germany  
Phone +49 4151 12-0  
Fax +49 4151 3797  
tablet@fette-compacting.com

**Fette Compacting America, Inc.**

400 Forge Way  
Rockaway N.J. 07866, USA  
Phone +1 973 5868722  
Fax +1 973 5860450  
sales@fetteamerica.com

**Fette Compacting America Latina Ltda.**

Av. Cambacica, 1200 módulo 10  
Parque Imperador  
CEP 13097-160  
Campinas / SP, Brazil  
Phone / Fax +55 19 37969910  
contato@fette-compacting.com.br

**Fette Compacting Mexico, SA de CV**

Adolfo Prieto No. 1638  
Colonia Del Valle Sur  
03100 Mexico, DF, Mexico  
Phone +52 55 40000653  
tablet@fette-compacting.com

**Fette Compacting (China) Co., Ltd.**

No. 9 Shengtong Road,  
Moling Sub-District,  
Jiangning Development Zone,  
211111 Nanjing  
Jiangsu Province, P.R.C., China  
Phone +86 25 52121818  
Fax +86 25 52129951  
fcn@fette-compacting.com

**Fette Compacting Machinery India Private Limited**

A - 406 /407, 4th floor, Atrium 215,  
Next to Hotel Courtyard Marriott,  
Near J. B. Nagar Metro station,  
Andheri – Kurla Road, J. B. Nagar,  
Andheri (East)  
400 093 Mumbai, India  
Phone +91 83 26750355  
sales.in@fette-compacting.com

Competence Centre  
Plot No S 115, Phase III B  
Verna Industrial Estate  
Verna, Goa 403 722, India  
Phone +91 83 26750355

**Fette Compacting Asia Pacific Pte Ltd.**

107 Eunos Avenue 3, #01-01  
Singapore 409837, Singapore  
Phone +65 659 25654  
Fax +65 654 71939  
infoasiapacific@fette-compacting.com

**Fette Compacting Ibérica SL**

Avenida Labradores, 1  
2ª Planta, Oficina 3  
28760 Tres Cantos, Spain  
Phone +34 91 8039689  
Fax +34 91 3483052  
fcib@fette-compacting.com

**Fette Compacting France**

1, Rue du Centre  
93160 Noisy Le Grand, France  
Phone +33 155 812121  
Fax +33 155 812120  
fcf@fette-compacting.com

**Fette Compacting Belgium BVBA**

Schaliënhoevedreef 1b  
2800 Mechelen, Belgium  
Phone +32 15 684260  
Fax +32 15 684269  
fcbe@fette-compacting.com

**EuroPharma Machinery Ltd**

Unit 12 Highview  
Bordon, Hampshire, GU35 0AX  
United Kingdom  
Phone +44 1420 473344  
Fax +44 1420 488030  
admin@europharma.co.uk

**Fette Compacting Middle East FZE**

Jebel Ali Free Zone, Jafza  
Lobby 14, Office 308, Dubai  
United Arab Emirates  
Phone +971 4 8808226  
dubai@fette-compacting.com

**Fette Compacting North-West Africa**

Tour d'Affaire Nord, Centre Commercial  
Bab Ezzouar – Regus 4ème Etg.  
16000 Algiers, Algeria  
Phone +213 770 117 007  
fcnwa@fette-compacting.com

[www.fette-compacting.com](http://www.fette-compacting.com)

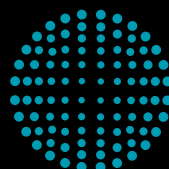

**FETTE  
COMPACTING**  
be efficient